



WMM77P

76.77 MHz LOW NOISE PRE-AMPLIFIER MODULE WITH PINS

REV A
April 2023

Key Features



- Frequency of 76.77 MHz
- For 50 Ω Source Impedance
- 1.5 Ohm Input Impedance
- 0.40 dB Noise Figure
- 40.0 dBm Max P_{IN}
- 21.0 dBm Output IP₃
- 28.0 dB Gain
- 10.0 dBm P_{1dB}
- 20.0 dB Output Return Loss
- Unconditional Stable, $k > 1$
- Minimal Magnetic

Product Description

WMM77P is integrated with WanTcom proprietary low noise amplifier technologies, high frequency micro electronic assembly techniques, and high reliability designs to realize optimum low noise figure, wide optimum noise source impedance, and high performances together. With single +10.0V DC operation, the amplifier has the ESD and high RF power protection at the input port. The amplifier has 0.72" x 0.64" x 0.40" 6-pin package.



Applications

- Magnetic Resonance Imaging
- RF Measurement
- Medical Equipment
- Current Sensor

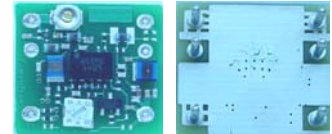

Specifications

Summary of the key electrical specifications at room temperature, 21 °C

Index	Testing Item	Symbol	Test Constraints	Min	Nom	Max	Unit
1	Gain	S ₂₁	76.77 MHz	27.7	28.0	28.3	dB
2	Gain Variation	ΔG	76.77 MHz +/- 0.5 MHz		±0.05	±0.1	dB
3	Input Impedance	RE [Z _{in}]	76.77 MHz De-embedded to bottom of input Pins	1.25	1.5	2.0	Ohm
		IM [Z _{in}]		-1	0	1	Ohm
4	Output Return Loss	S ₂₂	76.77 MHz	20	23		dB
5	Reverse Isolation	S ₁₂	76.77 MHz	55	60		dB
6	Noise Figure	NF	76.77 MHz		0.40	0.50	dB
7	Output Gain 1dB Compression Point	P _{1dB}	76.77 MHz	7.0	10.0		dBm
8	Output Gain 0.1dB Compression Point	P _{0.1dB}	76.77 MHz	0.0	1.5		dBm
9	Output-Third-Order Interception Point	IP ₃	Two-Tone, 0 dBm each, 1 MHz separation	20.0	21.0		dBm
10	Current Consumption	I _{dd}	V _{dd} = +10.0 V		17	20	mA
11	Power Supply Operating Voltage	V _{dd}		+7	+10	+15	V
12	Thermal Resistance	R _{th,c}	Junction to case			220	°C/W
13	Operating Temperature	T _o		+10		+60	°C
14	Maximum RF Input Power	P _{IN,MAX}	76.77 MHz, 6% Duty Cycle, Z _s = 50 Ω			40	dBm
15	Saturate Recover Time	t _{sr}	10% to 90% from 20 dBm Pin		4	8	uS
16	ESD Protection, None Contact	V _{ESDN}	Input and Output Ports			16	kV
17	ESD Protection, Direct Contact	V _{ESD}	Input and Output Ports			6	kV

Absolute Maximum Ratings

Parameters	Units	Ratings
DC Power Supply Voltage	V	-0.5, +15.0
Drain Current	mA	30
Total Power Dissipation	mW	350
RF Input Power, 10% Duty Cycle, Z _s = 50 Ω	dBm	40,
Junction Temperature	°C	150
Storage Temperature	°C	-55 ~ 100
Operating Temperature	°C	0 ~ +70
Thermal Resistance ¹	°C/W	220

Operation of this device beyond any one of these parameters may cause permanent damage.

Functional Block Diagram

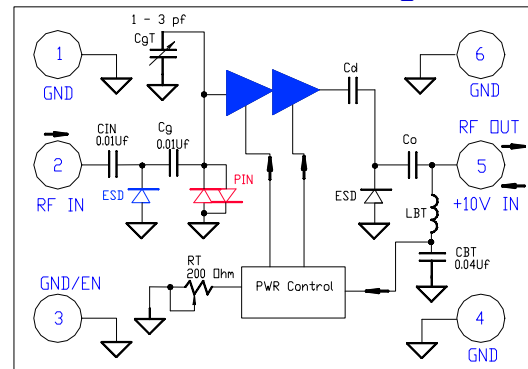

¹ The last stage transistor dominates the heat dissipation. The drain bias voltage is +3.5V and the drain current is 10.0 mA. The total power dissipation of the last stage transistor is thus 35 mW. The junction temperatures arise 0.035 x 220 = 7.7 (°C).

Specifications and information are subject to change without notice.



WMM77P

76.77 MHz LOW NOISE PRE-AMPLIFIER MODULE WITH PINS

REV A
April 2023

Ordering Information

Model Number	WMM77P
--------------	--------

ESD waffle tray is used for the packing. Contact factory other packing option for higher volume order.

Typical Data

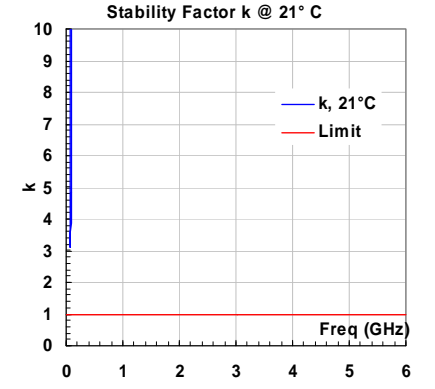
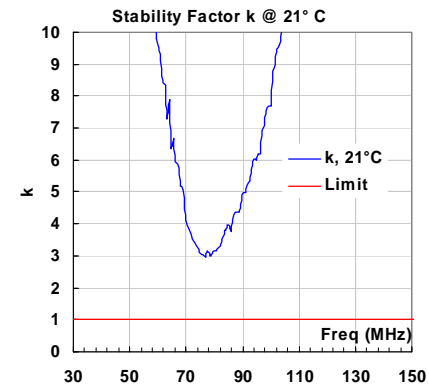
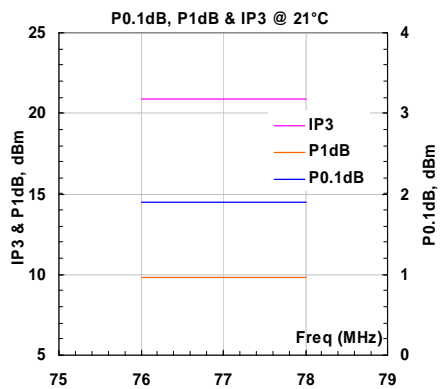
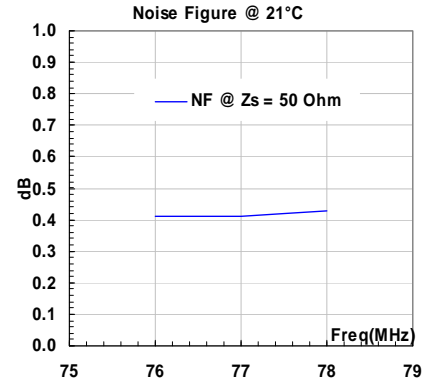
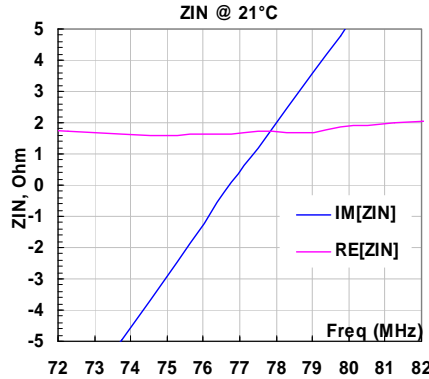
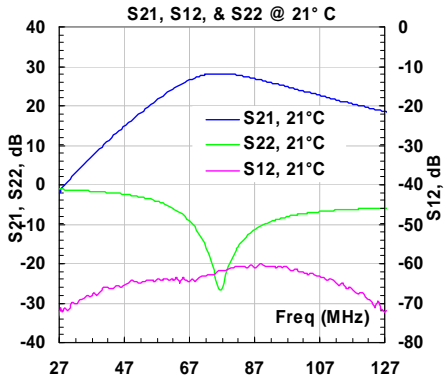

Outline,

PIN	1	2	3	4	5	6
FCFN	GND	IN	GND/EN	GND	OUT/+10V	GND

NOTES:
Non-magnetic

UNIT: INCH
[mm]

Tolerance:
X.XX - +/- 0.02"
X.XXX - +/- 0.010"

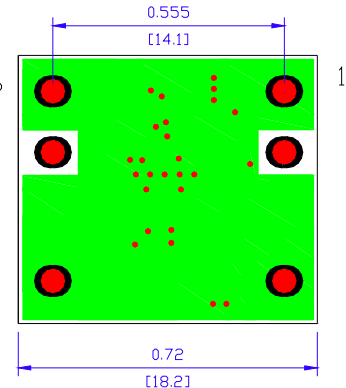
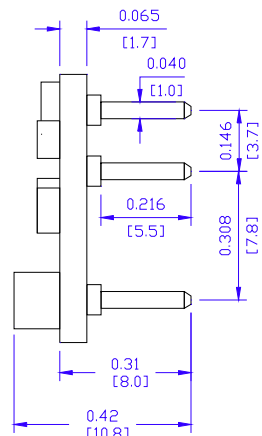
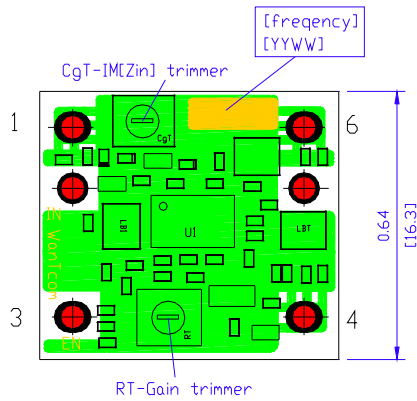

Specifications and information are subject to change without notice.



Foot Print/Test Board

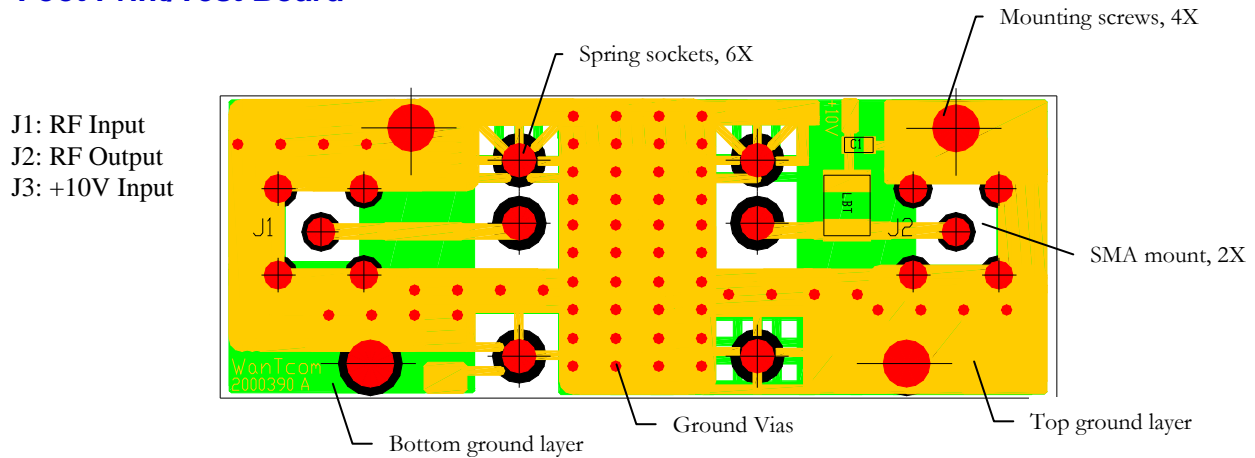

Application Notes:

A. Motherboard Layout

The recommended motherboard layout is shown in the diagram of **Foot Print/Mounting Layout**. Sufficient numbers of ground vias connecting the top and bottom ground layers are essential for the RF grounding. The width of the 50-Ohm microstrip lines at the input and output RF ports may be different for different property of the substrate. The ground plane on the backside of the substrate is needed to connect the center ground pad through the vias. The ground plane is also essential for the 50-Ohm microstrip line launches at the input and output ports.

The spring sockets, total of 6 counts, are used for plugging in the preamplifier.

No DC block capacitor is required at input RF port.

B. Preamplifier ground and isolation

The preamp S_{12} , as shown in **Typical Data** plot cross the wide frequency band, which is measured on WanTcom test fixture 8000100. The low S_{12} value of the system is the key for the stability of the amplifier and the coil system. The MRI coil system stability and k value will be lowered if the external additional feedback is introduced by improper pre-amp grounding, poor feed board layout, and mis-wirings, etc.

In order to have stable coil system, the input port and output port isolation, without the pre-amp assembled but all other components are on the feed board, is required to have minimum of 55 dB across the frequency of 1 MHz to about 500 MHz. Failed to reach this number may result unstable of the pre-amps, especially in a multi-channel system.

The system isolation can be measured with a VNA between the input and output ports, Pin 2 and Pin 5, assuming all the components on the feed board are assembled except the preamplifier. Some frequency points may have higher S_{12} and the root causes need to be identified before assembling the preamplifier.

The common mistakes on poor system S_{12} are

- Poor output port shield on traces, connectors, and other circuitries;
- Output port trace going back to the input port side and cause additional coupling;
- Missing entire center ground pad;
- Improper ground layout on the signal layer.



C. Input high power protection

The preamplifier has built-in Pin diodes at the input port and can handle limited input RF pulse power level up to 40 dBm, 10% duty cycle, at 50-Ohm source impedance, during the transmitting period. The maximum safe input power level is lowered if the source impedance is lower. For example, if the short circuit of PIN diodes are presented at the input of the amplifier, the maximum non-damage power level can be as low as 30 dBm if the source impedance is around 1.0 Ohm range. Any short circuit mechanism is undesired at the input of the amplifier during the transmitting cycle.

The amplifier may be destroyed permanently if the input RF energy exceeds the limit level of 40 dBm.

Different coil designers have different ways to do the additional protections. Due to many proprietary techniques are involved and we would like not to reveal in detail here.

Regardless all these techniques, the goals are similar during the transmitting cycle and follow technique or techniques is or are used:

- a) Turn the preamplifier off;
- b) De-tune the coil;
- c) Using PIN diodes to make the source impedance high at the input of the amplifier;
- d) Using quarter wavelength transmission line.

The most common mistake is to use 2 PIN diodes shunting to ground at the input of the amplifier. Due to the lower input impedance of the pre-amp, the RF voltage is very low at this node! Instead, the RF current is very high.

D. Gain setting

Each preamp has an onboard gain setting trimmer, RT, as shown in the Outline picture. The default gain is set at 28 +/- 0.3 dB. For different gain rather than 28 dB, use a fine flat screwdriver to fine tune RT to the desired gain value. Lower gain than 28 dB setting may degrade other performance such as P_{1dB} and IP_3 etc. Lower than 27 dB gain setting is not recommended.

For multi-channel application, RT can be used to fine-tune the amplitude balance between the channels.

E. Input Impedance Phase, IM[Zin], fine tuning

Each preamp has an onboard input admittance trimmer, CGT, as shown in the Outline picture. The default IM[Zin] is set at 0 +/- 1.0 Ohm. For installed coil and matching circuitries resonated at the desired frequency, use a fine flat screwdriver to fine tune CGT to the desired frequency. Make sure not tune CGT many times, which could result the failure of CGT.

For multi-channel application, CGT can be used to fine-tune the phase balance between the channels.

F. Noise figure measurement

The more accurate ultra low noise figure measurement requires low ENR noise source such as Keysight 346A, which has the ENR value of 6.0 dB. Refers to AN-105, www.wantcominc.com.

Due to the great impedance mismatch between the noise source, 50 Ohm, and the input impedance, 1.5 Ohm, of the amplifier, the measured noise figure will be around 0.05 dB higher than the actual number. In order to reduce this mismatch, a precision 6-dB attenuator is used between the noise source and the amplifier:

- a) Measure the 6-dB attenuator with a Full-Two-Port method calibrated VNA. Record the attenuation at 10 MHz, 100 MHz, and 1 GHz. The values may not be exactly 6 dB depending on the model number of the attenuator;
- b) Type in the noise source ENR values minus the measured attenuation values into the noise figure meter or system. For the 6 dB noise source, the updated ENR values can be from -1.0 dB to 0.0⁺ dB;
- c) Perform the noise figure calibration with the 6-dB attenuator in the system;
- d) Insert the amplifier between the attenuator and the noise figure meter input;
- e) Record the noise figure readings.

The 6-dB attenuator provides about 12.0 dB return loss to the noise source to reduce the mismatch at the output of the noise source.



WMM77P

76.77 MHz LOW NOISE PRE-AMPLIFIER MODULE WITH PINS

REV A
April 2023

Specifications and information are subject to change without notice.

WanTcom, Inc * Phone 01 952 448 6088 * FAX: 01 952 448 7188 * e-mail: sales@wantcominc.com * Web site: www.wantcominc.com